

Title		
Size	Number	Revision
A3		
Date:	2019/3/9	Sheet of
File:	C:\Users\... \Sheet1.SchDoc	Drawn By:

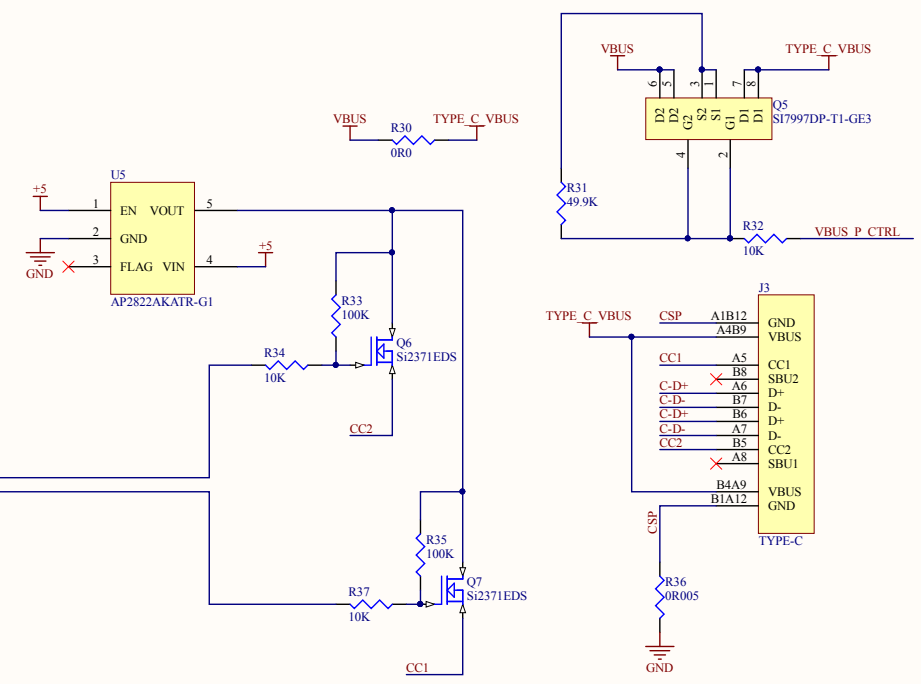
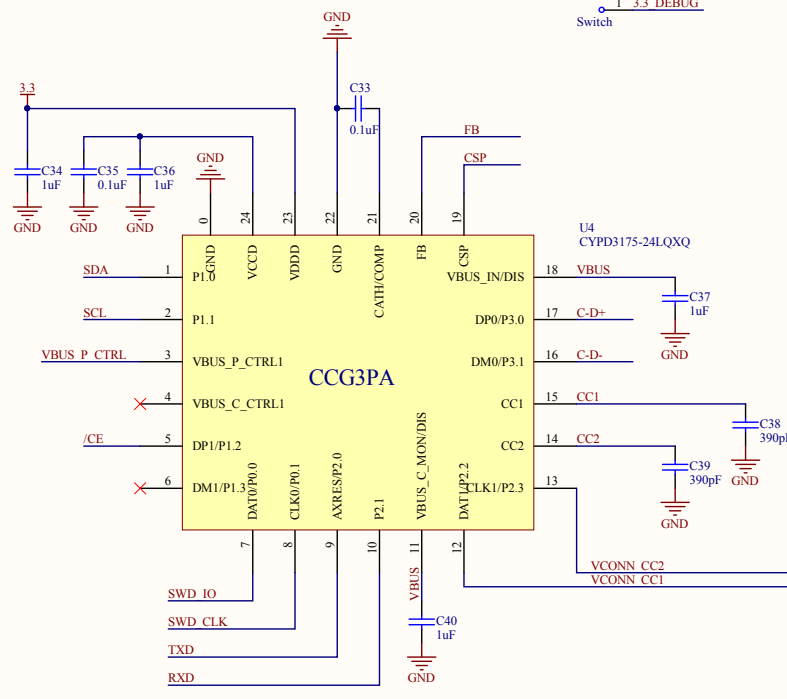
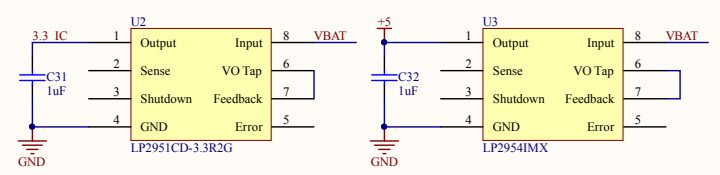
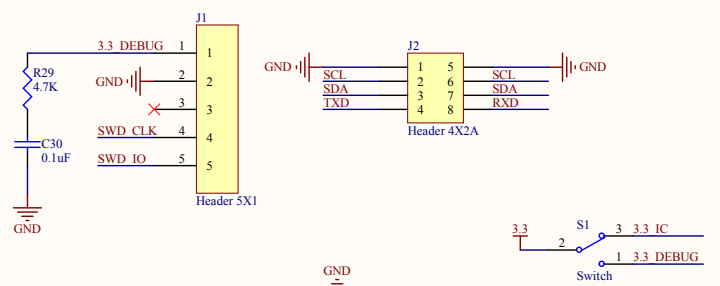

Title		
Size	Number	Revision
A3		
Date:	2019/3/9	Sheet of
File:	C:\Users\...\Sheet2.SchDoc	Drawn By: